

# saltigo

customized competence

**Axel Westerhaus**

1<sup>st</sup> LANXESS Investor Conference

September 15, 2006

A company of the  
**LANXESS**  
Group

# Saltigo Overview

## Key Figures

- Sales: ~ €400 m
- Products: ~ 500
- Customers: ~ 150
- Employees: ~ 1,400 worldwide
- Countries: Worldwide
- Production sites: Dormagen (GER)  
Leverkusen (GER)

| LANXESS Business Units        |                              |
|-------------------------------|------------------------------|
| <b>Performance Rubber</b>     | <b>Performance Chemicals</b> |
| Butyl Rubber                  | Material Protection Products |
| Polybutadiene Rubber          | Functional Chemicals         |
| Technical Rubber Products     | Leather                      |
| <b>Engineering Plastics</b>   | Textile Processing Chemicals |
| Lustran Polymers              | Rhein Chemie                 |
| Semi-Crystalline Products     | Rubber Chemicals             |
| <b>Chemical Intermediates</b> | Ion Exchange Resins          |
| Basic Chemicals               |                              |
| <b>Saltigo</b>                |                              |
| Inorganic Pigments            |                              |

A company of the  
**LANXESS**  
Group

**saltigo**  
customized competence

# Where do we come from? Our recent history in the Fine Chemicals business



A company of the  
**LANXESS**  
Group

**saltigo**  
customized competence

## Building Saltigo is more than restructuring

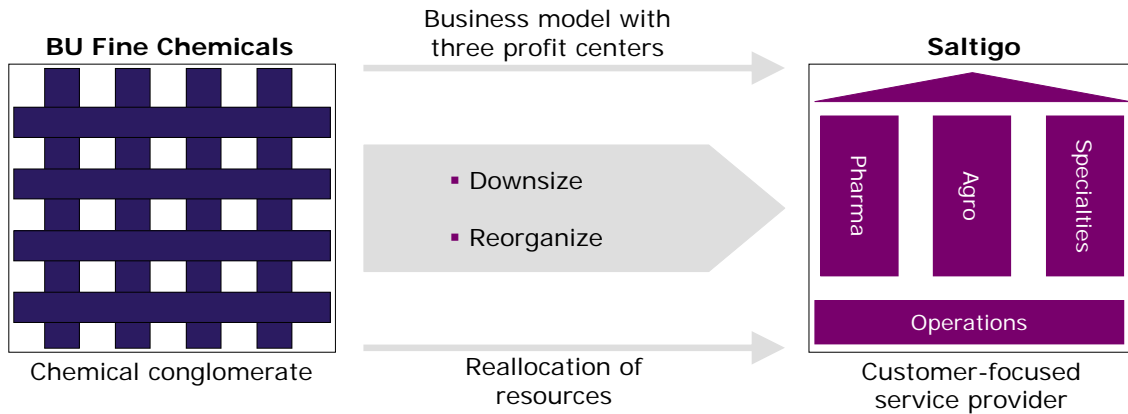

A company of the  
**LANXESS**  
Group

4

**saltigo**  
customized competence

## Saltigo – Attractive markets for custom manufacturing

Market volume  
custom manufacturing  
in € bn (excl. generics)

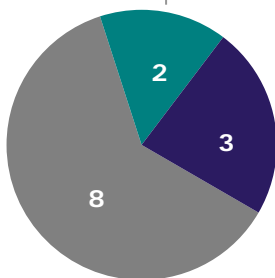

Agro



Specialty  
Chemicals



Pharma



A company of the  
**LANXESS**  
Group

5

**saltigo**  
customized competence

## Saltigo – A well positioned mid-sized player

| Type of suppliers  | Companies  | Annual sales       | Technology  |               |
|--------------------|--|--------------------|---|---------------|
| Low cost suppliers | > 500 player   | \$ 10-50 m         | <ul style="list-style-type: none"> <li>Narrow toolbox</li> <li>Engineering &amp; Chemistry capabilities</li> <li>India/China</li> </ul>                     | Niche players |
| Specialists        | > 200 players e.g. Bachem, Ems Dott.   | < \$ 100 m         | <ul style="list-style-type: none"> <li>(focused) technology players</li> </ul>  |               |
| Mid-size players   | ~ 20 players e.g. Dow, BASF, Rhodia, Eastman, Clariant, Albemarle, Cambrex, <b>Saltigo</b> | \$ 100 - 500 m     | <ul style="list-style-type: none"> <li>Mostly with broad toolbox</li> <li>Variable biomanufacturing capabilities</li> </ul>                                 | Full players  |
| Big players        | Lonza<br>DSM<br>Degussa  | > \$ 500 – 1,500 m | <ul style="list-style-type: none"> <li>Complete tool box</li> <li>State of the art multipurpose</li> <li>Variable bio-manufacturing capabilities</li> </ul> |               |

High number of competitors, but Saltigo's peer competitors are western based companies

- Lonza (EU)
- DSM (EU)
- Degussa (EU)
- Clariant (EU)
- Albemarle (US)

A company of the  
**LANXESS**  
Group

6

**saltigo**  
customized competence

## Optimized business setup for a stable Fine Chemicals company needs a balanced business mix

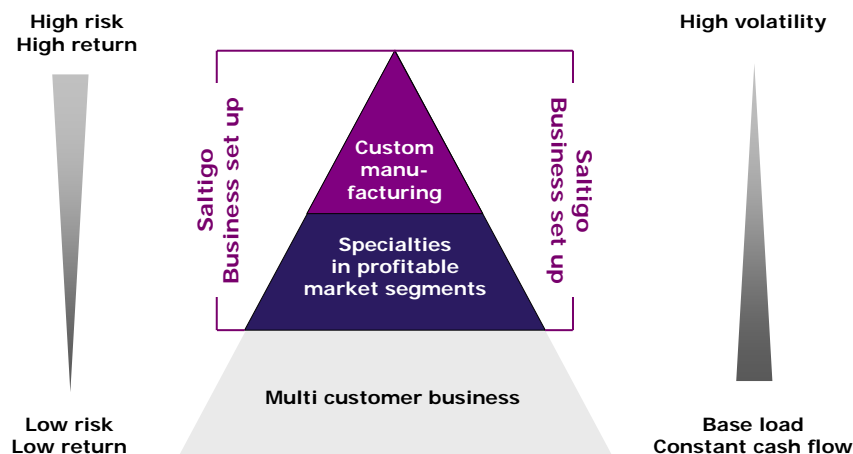

A company of the  
**LANXESS**  
Group

7

**saltigo**  
customized competence

## From the idea to the market



### Competencies of Saltigo

- Customized synthesis
- Customized process development
- Customized manufacturing
- Customized services

## Saltigo is a service provider with broad know-how

### What we do

- Chemical synthesis
- Process development
- Pilotation
- Scale up
- Production
- Registration support
- Analytical support

### What we have

- Highly educated & experienced employees
- Broad technology base
- High complex multi-purpose asset structure
- Know-how of chemical processes & technology
- Trust
- Track record
- Protection of know-how & IP
- Market access

## Efficiency and innovation – automatic and simultaneous process development

### Advantages

- Speed and throughput
- Safety
- Ecologically sound



A company of the  
**LANXESS**  
Group

10



**saltigo**  
customized competence

## Efficiency, profile and innovation – fluorochemistry for R&D partnerships

### We can offer

- More than 40 years of experience
- Comprehensive portfolio of procedures and compounds
- Customized services



A company of the  
**LANXESS**  
Group

11

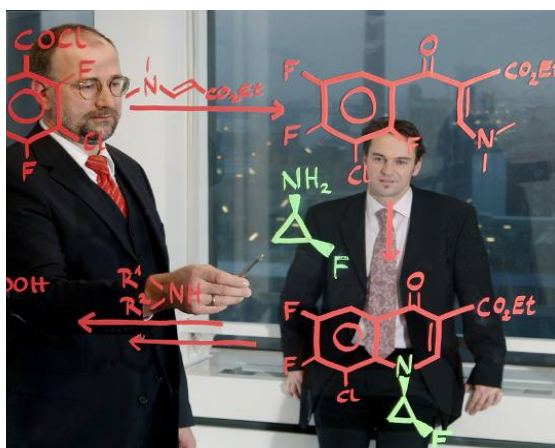

**saltigo**  
customized competence

## Profile and investment – huge expertise in small volumes

### Success factors

- Broad technology portfolio
- Integrated order processing
- Flexibility and reliability in terms of volumes and deadlines



A company of the  
**LANXESS**  
Group

12



**saltigo**  
customized competence

## Efficiency and investment – production at low temperatures

### State-of-the-art reactions allow

- Access to complex molecules
- High-quality products
- High yields



A company of the  
**LANXESS**  
Group

13

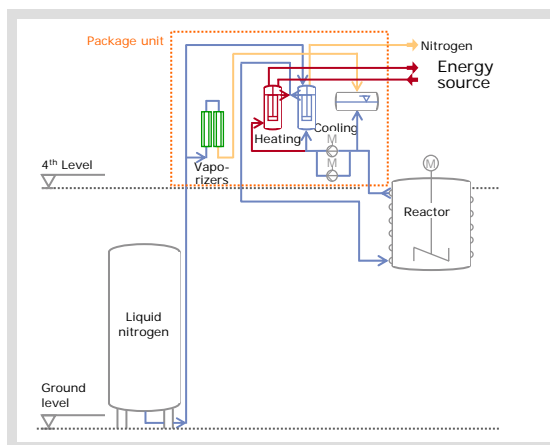

**saltigo**  
customized competence

## Profile and investments – GMP capacities for the pharmaceutical industry

### Our objectives

- High flexibility for our pharmaceutical customers
- Expansion of pharmaceutical custom manufacturing



A company of the  
**LANXESS**  
Group

14



**saltigo**  
customized competence

## Change in customer structure

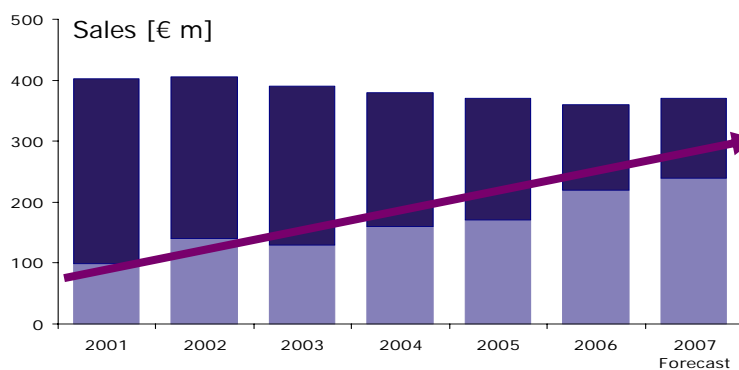

### CAGR 2001/2006

Total: approx. - 2%

- 12%

+ 20%

■ current and former Bayer business

■ other businesses

### Broadening the customer portfolio

A company of the  
**LANXESS**  
Group

15

**saltigo**  
customized competence



## Business is focused on custom manufacturing in IP protected stages

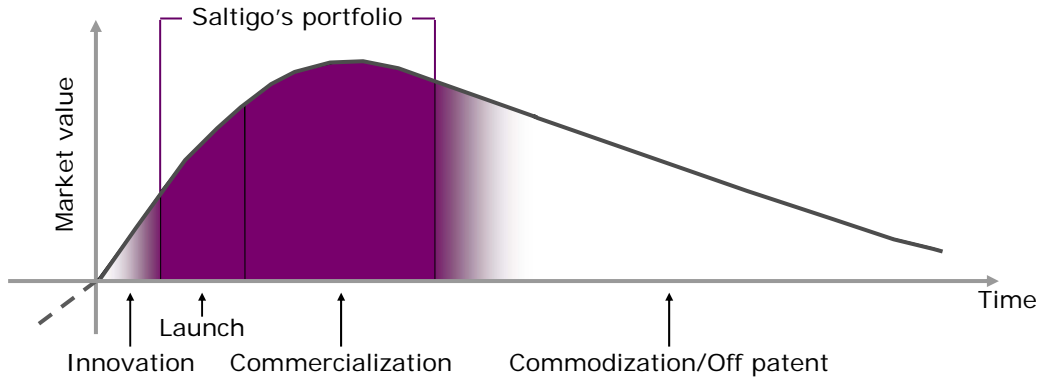

### Product life cycle

A company of the  
**LANXESS**  
Group

**saltigo**  
customized competence

16

## Saltigo brings innovation to life

- With great expertise in process development and a high tech manufacturing platform, Saltigo plays an important role in bringing new chemical products to the markets.

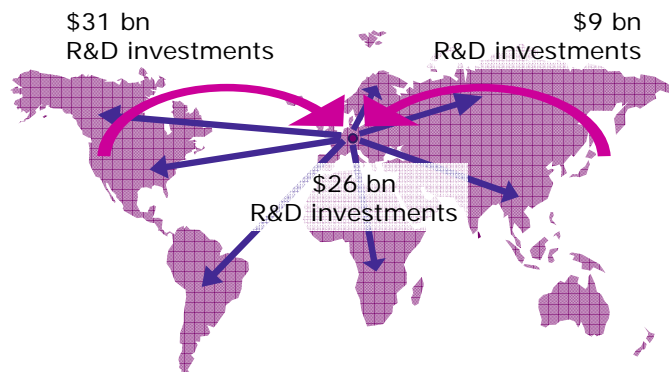

A company of the  
**LANXESS**  
Group

**saltigo**  
customized competence

17

## Saltigo gets things rolling

- Already one of the top players in custom manufacturing
- Advanced business model in custom manufacturing
- Broad technology base for complex syntheses
- Broad industry know-how
- Focused on innovative customers
- Saltigo is on the way to becoming a strong player in global custom manufacturing

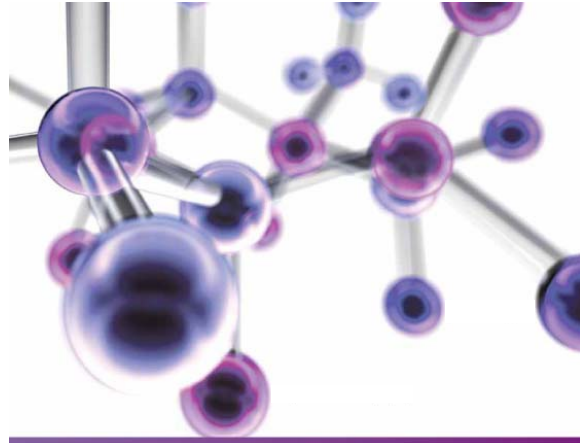

A company of the  
**LANXESS**  
Group

18

**saltigo**  
customized competence

## End products with involvement of Saltigo

**saltigo**  
customized competence



A company of the  
**LANXESS**  
Group

19

**saltigo**  
customized competence

# saltigo

customized competence

## Safe Harbor Statement

This Presentation contains certain forward-looking statements, including assumptions, opinions and views of the companies Saltigo GmbH and LANXESS AG or cited from third party sources. Various known and unknown risks, uncertainties and other factors could cause the actual results, financial position, development or performance of the companies to differ materially from the estimations expressed or implied herein. The companies do not guarantee that the assumptions underlying such forward looking statements are free from errors nor do they accept any responsibility for the future accuracy of the opinions expressed in this Presentation or the actual occurrence of the forecasted developments.

No representation or warranty (express or implied) is made as to, and no reliance should be placed on, any information, including projections, estimates, targets and opinions, contained herein, and no liability whatsoever is accepted as to any errors, omissions or misstatements contained herein, and, accordingly, none of the companies or any of its parent or subsidiary undertakings or any of such person's officers, directors or employees accepts any liability whatsoever arising directly or indirectly from the use of this document.